

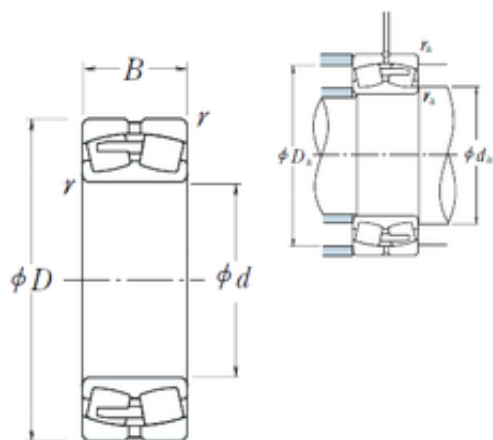

240/850CAE4 NSK Spherical Roller Bearing



Bearing No. 240/850CAE4

Size	850x1220x365 mm
Bore Diameter	850 mm
Outer Diameter	1220 mm
Width	365 mm
d	850 mm
D	1220 mm
B	365 mm
C	365 mm
r min.	7,5 mm
da min.	886 mm
Da min	1093 mm
Da max.	1184 mm
ra max.	6 mm
Weight	1350 Kg
Basic dynamic load rating (C)	11600 kN
Basic static load rating (C0)	28300 kN
(Grease) Lubrication Speed	150 r/min
(Oil) Lubrication Speed	190 r/min
Calculation factor (e)	0,28
Calculation factor (Y0)	2,4
Calculation factor (Y2)	3,6

240/850CAE4 Bearing 2D drawings and 3D CAD models