

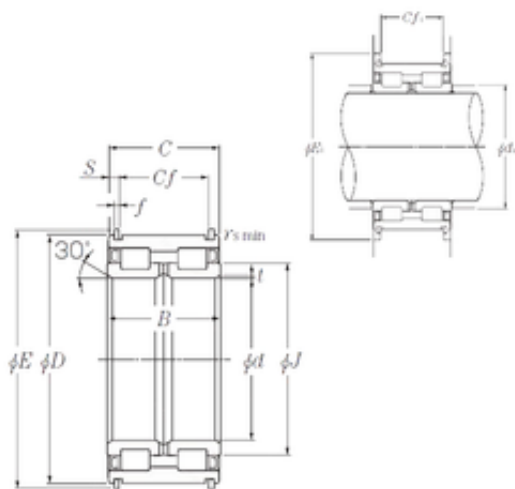

SL04-5072NR NTN Cylindrical Roller Bearing

Bearing No. SL04-5072NR



SL04-5072NR Bearing 2D drawings and 3D CAD models

Size	360x540x243 mm
Bore Diameter	360 mm
Outer Diameter	540 mm
Width	243 mm
d	360 mm
D	540 mm
B	243 mm
C	241 mm
E1	600 mm
t	3,5 mm
f	10 mm
r min.	2 mm
E	565 mm
J	421 mm
S	23,5 mm
da	372 mm
Cf	194 mm
Cf1	194 mm
Weight	203 Kg
Basic dynamic load rating (C)	3 750 kN
Basic static load rating (C0)	8 300 kN